



The CONVERGE® Huddle is a professional audio DSP mixer that addresses today's AV needs in huddle rooms and similarly sized meeting spaces.

With CONVERGE Huddle, audio and video collaboration applications can be accomplished through a single cable connection to users' Bring Your Own Devices (BYOD), such as laptops, tablets, and smartphones that run applications such as Spontania®, Skype®, Skype for Business, etc.

Audio Signal Processing

- + Next-gen Acoustic Echo Cancellation processing
- + Distributed Echo Cancellation® on every mic input
- + Noise Cancellation with Adaptive-Ambience
- + Acoustic Intelligence with faster convergence

Clutter-Free Connection

- + Connects laptop via single USB 3.0 connection**
- + Connects display screen, camera, mic and speaker
- + Connects PC / mobile device through Bluetooth (future)

Flexibility

- + Compatible with ClearOne or any 3rd party camera
- + Compatible with ClearOne or any 3rd party mic
- + Compatible with ClearOne or any 3rd party speaker

Bring Your Own Application

- + PC-based video conferencing
- + PC-based audio conferencing
- + Audio conferencing via mobile devices
- + In-room wired presentation

Simple Configuration

- + User-friendly Pro CONSOLE® software
- + Pre-configured template
- + Auto-discovery of devices
- + System monitoring and troubleshooting

Compact Form Factor

- + Half rack width, 1RU rack height
- + Flexible mounting under a conference table, or in a closet, rack or on the wall, or VESA mounting



APPLICATIONS

Audio Conferencing

Video Conferencing

Presentation

WORKSPACES

Huddle Rooms

* Requires DisplayLink driver on laptop
USB 3.0 cable can be extended up to 10m, 30m

Front Panel

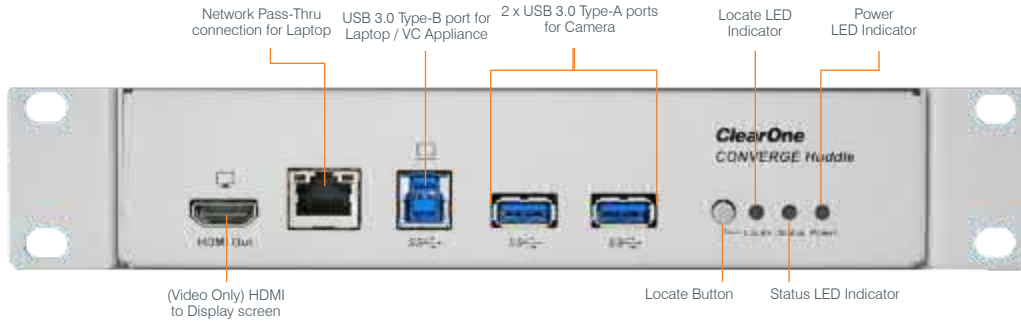

Back Panel

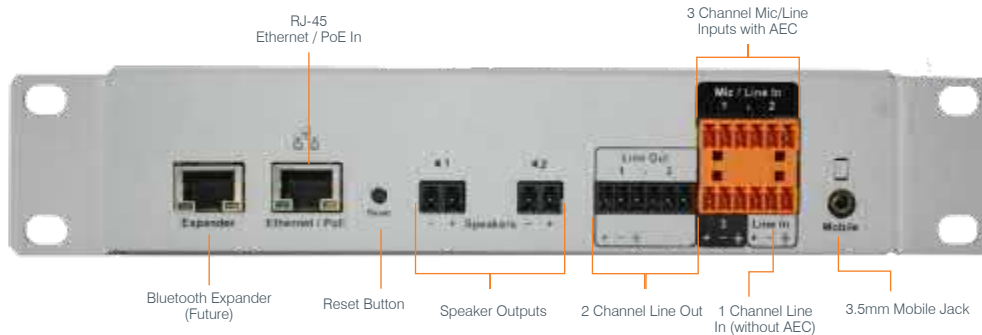

PRODUCT SPECIFICATIONS

Unless otherwise specified, all measurements are performed with a 20Hz to 22kHz BW (no-weighting).

MIC/LINE INPUTS & OUTPUTS

Inputs: 3 Channels balanced audio Mic/Line inputs with AEC, 1 Channel balanced audio Line input without AEC, 3.81mm Orange color Phoenix/Euroblock type male header, Push-on mini-terminal block

Line Outputs: 2 Channel Balanced audio Line outputs, 3.81mm Black color Phoenix/Euroblock type male header, Push-on mini-terminal block

Frequency Response:
20Hz – 22kHz @ 0dBu, +/- 0.5dBu

EIN (Equivalent Input Noise):
20kHz BW, max gain, $R_s = 150\Omega$, -126dBu

THD + N (Total Harmonic Distortion + Noise):

- 20Hz – 22kHz @ 0dBu, line level, <0.01%
- 20Hz – 22kHz @ -56dBu, mic level, <0.2%

Dynamic Range:
20Hz – 20kHz @ 0dB, >105dB

Crosstalk (Mic/Line):
Channel to Channel, stimulus at 20dBu to receptor at -56dBu, 1kHz, < -98dB

Input Impedance:
Balanced (line to ground), 2.2k Ω , 1%

Nominal Input Level:
Adjustable -56dB to 0dB, 7dB step coarse gain

Maximum Input Level: -65dBu to 20dBu

Phantom Power: 48V, Impedance 6.81k Ω

Output Impedance:
Balanced (line to ground), 95 Ω , 1%

Output Level:
0dBu (Nominal), 20dBu (Max)

HEADSET AUDIO

Port Type: 3.5mm TRRS connector

Frequency Response:

- Headset In: 20Hz – 22kHz, +/- 3dB
- Headset Out: 20Hz – 22kHz, +/- 1dB

THD + N (Total Harmonic Distortion + Noise):

- Headset In: 20Hz – 22kHz @ -7.782dBu nominal, <0.01%
- Headset Out: 20Hz – 22kHz @ 0dBu, <0.2%

Dynamic Range:
20Hz – 20kHz @ 0dB, >95dB

USB 3.0 TYPE-B

Location: Front Panel
Number of Ports: 1
Devices: PC/laptop/Mac/VC Appliance
Networks: For Audio/Video and Network

USB 3.0 TYPE-A

Location: Front Panel
Number of Ports: 2
Devices: Camera
Compatible: USB 2.0
USB Power Sourcing: 5V @ 500mA each

NETWORK PASSTHROUGH

Port Type:
RJ-45, 10/100/1000Mbps, passthrough to USB-B 3.0

EXPANDER

Ports Type: RJ-45 (Cat5e or Cat6)
Expander Out: Proprietary Peripheral Bus
Cable: Solid core, factory terminated Cat 5e or 6 cable
Distance: Up to 200' (60M)
Device: Bluetooth Expander (Future)

AMPLIFIER OUTPUT

Type: 5.08mm Black Header, Male, Phoenix type Euroblock

Speaker Output Port: Dual binding posts

Audio: 2 Channels
Output Power: 10W Max, 8 Ω load

Frequency Response:
20Hz – 22kHz @ 10dBu, +/- 0.5dBu

THD + N (Total Harmonic Distortion + Noise):
20Hz – 22kHz @ 10dBu, 1W, <0.3%

Dynamic Range:
20Hz – 22kHz @ 20dB, >102dB with 20kHz digital low pass filter

Crosstalk (Mic/Line):
Channel to Channel, stimulus at 20dBu to receptor, < -70dB

VIDEO

Port Type: HDMI output connector
Location: Front Panel
Resolutions:

- 1600 x 1200p @ 60Hz, 4:3 ratio
- 1920 x 1200p @ 60Hz, 16:10 ratio
- 2560 x 1440p @ 60Hz, 16:9 ratio

LEDs

Location: Front Panel
Status LED: Blue / Red
Locate LED: Blue / Red
Power LED: Blue

ETHERNET

Port Type:
RJ-45, 10/100Mbps Ethernet Network, Auto Negotiation

POE, POWER & THERMAL

Power Type: PoE
Port Type: RJ-45
Power Source:
PoE power injector (Midspan), or PoE Ethernet Network Switch (Endspan)
IEEE 802.3at, Mode A or B
Mains Voltage: 100-240V AC, 50/60Hz
Power Consumption: 34 Watts Typical
Thermal: 116 BTU/Hr Typical
Operating Temperature:
14°F (-10°C) to 104°F (40°C) Ambient Temperature

RESET

Factory Reset: Press continuously for ~10 seconds.

DIMENSION & WEIGHT

Width x Depth x Height:
7.52" x 7.83" x 1.73" (191mm x 199mm x 44mm)
Unit Weight: 2.9 lbs (1.32 kg) (Approximately)

PRODUCT SPECIFICATIONS

MOUNTING

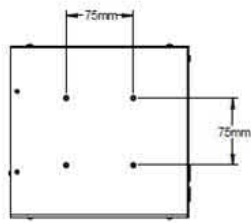

STANDARD MOUNTING PATTERN
FOR USE WITH M4 SCREWS

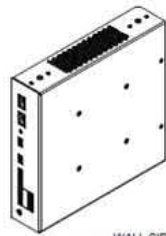

WALL SIDE
(MOUNT NOT SHOWN)

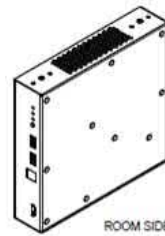

ROOM SIDE

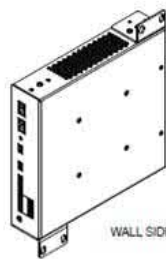
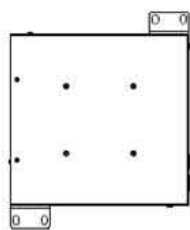

WALL SIDE

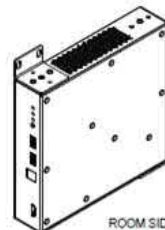

ROOM SIDE

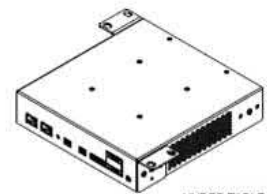

UNDER TABLE

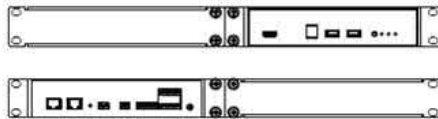

SINGLE RACK MOUNT
EITHER FACE FORWARD

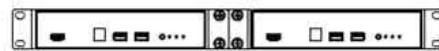

DUAL RACK MOUNT
EITHER FACE FORWARD

PART NUMBER

Part Number	Product Name
910-3200-701	CONVERGE Huddle
910-3200-702-30	USB 3.0 Cable – 30 feet
910-3200-702-100	USB 3.0 Cable – 100 feet
910-3200-703	Rack Mounting kit for CONVERGE Huddle

RELATED SKUs

Audio	Ceiling Mic Array Analog-X
	Ceiling Mic Array
	DIALOG® 20 Wireless Mics
	Wired Tabletop Mic
	Wired Tabletop Delta Mic
	Ceiling Speakers
	Wall Speakers
Video	COLLABORATE® Pro 300
	COLLABORATE Versa 100
	COLLABORATE Versa 150
	Spontania®
	UNITE® 200 PTZ Camera
Power	PoE+ Power Injector
	PoE Power Injector



Call Us: 703-222-3200 opt: 1

SALES AND INQUIRIES

Headquarters

5225 Wiley Post Way
Suite 500
Salt Lake City, UT 84116

US & Canada

Tel: 801.975.7200
TollFree: 800.945.7730
Fax: 801.303.5711

International

Tel: +1.801.975.7200
global@clearone.com

Sales

Tel: 801.975.7200
sales@clearone.com

TechSupport

Tel: 801.974.3760
TollFree: 800.283.5936
tech.support@clearone.com

Transform any meeting room into a professional grade video collaboration room with the UNITE PTZ Camera. USB 3.0 connectivity enables you to easily add Full-HD video to your UC or video application. Powerful optical zoom and wide field of view make this camera ideal for medium to large meeting spaces. Full high definition video in up to 1080p60 resolution ensures the remote sites see every detail, even when displayed on a large screen.



USB3.0

DVI-I

Features

Use with Familiar UC Video Applications

UNITE is designed to be used with many popular UC video applications such as ClearOne's media collaboration solutions, CTI AnyMeeting, BlueJeans, GoToMeeting, Skype and Google Hangouts.

Easy Installation and Multiple Video Outputs

In addition to USB 3.0, UNITE also has a standard DVI-I interface for maximum flexibility. Connect the camera to virtually any video conferencing system or capture device using analog or digital signals.

RS-232C Interface for Remote Control

All camera settings and pan/tilt/zoom functions are accessible using an RS-232C interface and industry standard VISCA protocol commands.

Superb High-Definition Experience

With two megapixel HD CMOS sensors and frame rates up to 1080p60, far end participants enjoy super smooth and crystal clear video.

12x Optical Zoom with Wide Angle Lens and Full Pan, Tilt, and Zoom (PTZ)

A powerful 12x optical zoom wide angle lens combined with fast and stable auto focus ensure all participants in the room can be seen.

Up to 128 Camera Presets

Camera presets make it easy to move from speaker to speaker, or quickly jump from people to other presentation tools in the room like flip charts and whiteboards.

A Wide Variety of White Balance Mode Selections for the Perfect Color Experience

Multiple white balance modes like automatic tracking, and "one push" make it fast and easy to meet the requirements of different users in changing environments.

Multi-Function Remote Control

Users easily access camera settings like pan/tilt/zoom and presets with the included infrared remote control.

Flexible Installation Options

The camera can be mounted upside down, directly above a display to maximize eye contact with far end participants, or from the ceiling to capture content on whiteboards, flipcharts or other familiar meeting room tools.

Combine UNITE with these ClearOne audio solutions to enhance your UC experience

- + CHAT® 150
- + CHATAAttach® 150
- + INTERACT® AT series
- + INTERACT Pro series
- + CONVERGE® Pro series
- + VIEW® Pro series
- + Spontania
- + COLLABORATE® Room Pro